

APPLICATION OF SYSTEM SIMULATION TO WCH BOILER SELECTION

Jan Hensen
University of Strathclyde
Energy Systems Research Unit
75 Montrose Street
Glasgow G1 1XJ, Scotland, UK
jan@esru.strath.ac.uk

Karel Kabele
Czech Technical University in Prague
Faculty of Civil Engineering
Thákurova 7
166 29 Prague 6, Czech Republic
kabele@fsv.cvut.cz

ABSTRACT

This paper reports the first results of an ongoing project aimed at generating design information/knowledge for wet central heating (WCH) refurbishment in multi-family houses in Central Europe. In that practical context, integral modelling and simulation of a building and its heating system is demonstrated. Given the underlying importance of the dynamic thermal interactions, building and plant are modelled at a high level of resolution.

INTRODUCTION

In the Czech Republic and neighbouring Central European countries, energy and fuel have been heavily subsidised in the past. In the emerging market economy this is an unwanted situation.

Many current activities/organisations aim to improve the energy situation and the associated impact on the environment by improvements in the built environment. A major impact is to be made in case proper design tools/information is available. We believe that modelling and simulation can play an important role in this respect.

One area in buildings which needs improvement is the supply and control of heating. A large proportion of the Czech housing stock consists of multi-family houses. Usually these buildings have a centralised boiler, with almost no temperature control on the individual apartment level. Modelling and simulation is the technique which is used in an ongoing project aimed at generating design information/knowledge for refurbishment of these systems.

This paper reports initial results of this project. First the background is further elaborated. Then a case study is described in terms of modelling approach and simulation results. The paper finishes with conclusions and indicating future work in terms of the modelling and simulation exercises as well as in practical terms regarding the heating systems.

BACKGROUND

One of the conditions for proper functioning of a wet central heating system is the balance between the boiler and the rest of the heating system (pipes, radiators, etc.). Each part of the overall system has its own (different) dynamic thermal properties (such as thermal inertia and mass). The thermal sub-

systems are coupled by the water flow, distributing the heat from the boiler to the heaters

In traditional systems with gravity circulation, no individual control of the heaters and a solid fuel boiler, the water flow rate is related to the boiler output, and it is actually possible to design such a system assuming steady state conditions. Nowadays such systems are no longer acceptable mainly because they are very restricted with respect to control of the heat output. As a consequence, very often refurbishment takes place.

Usually, this involves replacement of the boiler while the pipes and radiators remain the same. If the change involves additional incorporation of any control elements (thermostatic valves, central thermostatic control), it is effectively necessary to change the gravity circulation into forced circulation. In addition to that, due to energy policy, often a boiler of a different fuel type is selected (gas or light oil, instead of solid fuel). At this moment the balance of the overall system is disturbed, which will result in malfunction of the heating system or at least in increased instead of reduced fuel consumption.

The system designer now faces the challenge to select a suitable boiler in terms of: lightweight or cast-iron boiler, condensing or non-condensing boiler, capacity according to the original specifications (usually considerably oversized) or recalculated, etc. Some of the factors which should be considered include:

- boiler type,
- design temperatures,
- capacity of the system,
- control of the system (local, central, or both), and
- thermal inertia of building and heating system.

As elaborated elsewhere in more detail (Kabele 1996a, 1996b) it is quite difficult to predict in a general sense the impact of these factors on

- fuel consumption,
- control requirements for the system, and
- the resulting quality of the indoor environment (temperature amplitudes, etc.).

It is possible to perform experiments in a laboratory, or solve practical problems afterwards with additional technical solutions. However, a much less

expensive - and potentially better - approach is to use computer modelling and simulation to predict the future behaviour of suggested system arrangements.

PROBLEM DESCRIPTION

The ongoing project mentioned in the Introduction is going to address various types of buildings and WCH systems. Due to space constraints, this paper is limited to one case study only.

The current study is related to the refurbishment of the multi-family house shown in Figure 1 which is located in Smichov, a region in Prague. The house was built in 1966, and is representative for a large proportion of the current Czech housing stock.

The heat losses of the house under design conditions amount to 29 kW when calculated according to the prevailing Czech standards.



Figure 1 Reconstructed multi-family house

For the moment there are no structural changes to the building in terms of heat loss reductions because of economical considerations. The main changes of interest to the current work are related to the boiler which had to be changed from solid-fuel fired to a more modern natural gas type.

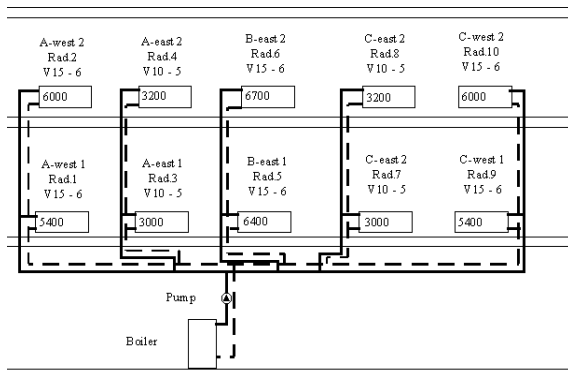

Figure 2 Schematic of the WCH system

The existing boiler has a water-side capacity of about 55 kW, which is actually considerably higher than the above mentioned heat demand of the building. The boiler capacity is also much higher than the

total installed capacity of the radiators, which is 44 kW, assuming a 90 C to 70 C temperature difference for each radiator. The existing 2-pipe WCH system is shown in Figure 2. The system has cast-iron column radiators. Effectively there was only manual control of the boiler

In terms of the replacement boiler the main questions were whether to:

1. install a heavy-weight (cast iron) or a light-weight (steel or copper) boiler, and
2. size traditionally (i.e. 55 kW), size equal to the total radiator capacity (i.e. 44 kW), or size according to the total heat losses of the building (i.e. 32 kW)?

MODELLING

ESP-r (ESRU 1996) was used as the modelling and simulation environment. The building model comprises 12 thermal zones representing the main body of the multi-family house described above. A previous paper (Hensen 1995) gives an overview and examples of various approaches to system simulation in buildings; from purely conceptual to very explicit. In the current study a high level modelling approach was adopted, in order to be able to differentiate between various heating system options. A comprehensive description about plant modelling in ESP-r in general, including the various plant component models used in the current case, can be found in (Hensen 1991).

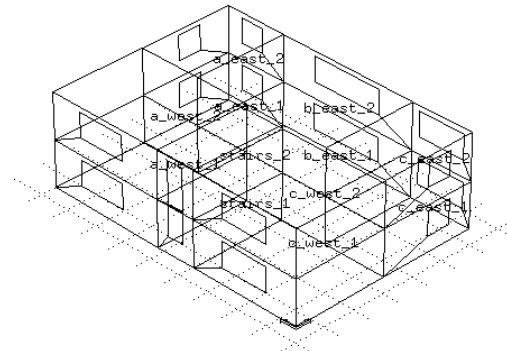

Figure 3 ESP-r model of the building

Due to space constraints, description of the plant model is limited here to the dominant plant component:

The boiler model is based on a plant component model specification described by Dachelet et al. (1988), and Laret (1988, 1989), and has been made available in ESP-r for two reasons:

1. the model represents a boiler type which is in widespread use in EU countries, and
2. to demonstrate how a TRNSYS-type model (SEL 1994) can be incorporated employing only slight

modifications.

The model simulates the thermal behaviour of a fuel-oil or gas-fired conventional boiler with aquastat control. A main control dictates whether the boiler is on or off. When the main control is on, the current system return water temperature T_j is checked against the aquastat set point T_{set} and if $T_j < T_{set}$ the boiler is controlled such that the average boiler outlet temperature T_x equals T_{set} . The boiler is modelled as a set of two heat exchangers supplied by three fluids: (1) the combustion gas, (2) the heat distributing water, and (3) ambient air. The reader is referred to the very thorough description by Dachelet et al. (1988) for further information.

Although the model is basically a static model, Dachelet et al. do propose a way to modify the model such that dynamic effects may be studied. This is done by introducing two fictitious thermal masses on the water system. One capacity is coupled to the system return water side, and the other to the boiler exit. When no other information is available, they suggest to distribute the water and boiler thermal capacitance evenly.

As elaborated in (Hensen 1991), ESP-r follows a slightly different approach in that the two nodes are directly coupled, and that the boiler net heat output is represented by a heat flow into the water Q_w which is applied to the second node. This approach results in a model as schematically shown in Figure 4.

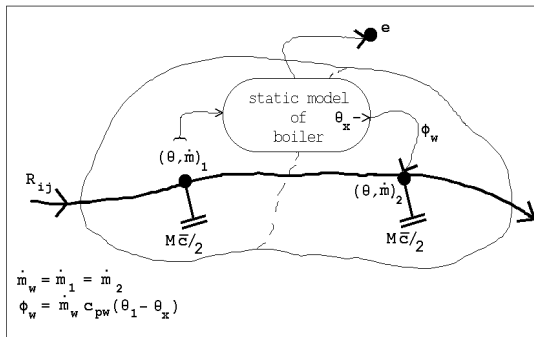

figure 4. Schematic representation of two node dynamic boiler model which uses internally a static boiler model after Dachelet et al. (1988)

In this type of model, distinction is made between PARAMETERS, INPUTS, and OUTPUTS.

PARAMETERS are dimensional values which are constant and specific to the equipment considered:

1	M	component total mass [kg]
2	c	mass weighted average specific heat [J/kgK]
3	m_f	fuel mass flow rate [kg/s]
4	CO_2	volumetric ratio of CO_2 in flue gases during operation [-]
5	$(AU)_0$	heat exchange coefficient water / flue gases in nominal conditions [W/K]

6	K_1	sensitivity coefficient for AU [-]
7	K_2	sensitivity coefficient for AU [-]
8	Y_w	heat loss coefficient to the environment if OFF [W/K]
9	DY_w	heat loss increase to the environment if ON [W/K]
10	K_w	weighting factor for defining mean water temperature [-]

11	$m_{f,0}$	fuel nominal mass flow rate [kg/s]
12	$m_{w,0}$	water nominal mass flow rate [kg/s]
13	$(CO_2)_0$	nominal ratio of CO_2 in flue gases [-]
14	C_1	coefficient for defining specific heat of flue gases [J/kgK]
15	C_2	coefficient for defining specific heat of flue gases [J/kgK]
16	c_{pf}	fuel specific heat [J/kgK]
17	H	fuel heating value [J/kgK]

INPUTS are variables which are computed in other areas of the program and which may vary each time-step. For the boiler model, the INPUTS are:

1	T_1	system water return temperature [C]
2	m_w	water mass flow rate [kg/s]
3	T_e	temperature of the environment [C]
4	T_a	air temperature (assumed $T_a = T_e$) [C]

and include two **control variables**

5	T_{set}	aquastat set point [C]
6	ON/OFF	boiler main control signal [-]

OUTPUTS are variables computed by the component model which may be printed out or which can be exported to other areas of the program. Here they are regarded as additional output variables:

1	T_x	water exhaust temperature of the static model [C]
2	m_w	water mass flow rate [kg/s]
3		mean useful power [W]
4		mean consumed power [W]
5		mean fuel mass flow rate [kg/s]
6		rate of burner operation time [-]
7		rate of burner stand-by time [-]
8		global efficiency of the boiler [-]
9		efficiency during operation [-]
10		effectiveness of equivalent heat exchanger [-]
11		heat transfer coefficient of heat exchanger [W/K]
12	Q_w	net heat input into the water [W]

Two OUTPUTS are used to calculate the net heat input into the water:

$$Q_w = m_w c_{pw} (T_x - T_1) \quad (W)$$

which is then applied to the second boiler model node as indicated in Figure 4.

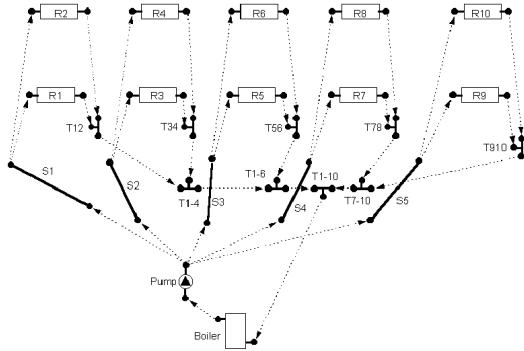

Figure 5 Schematic plant nodal network representation of the WCH system

The boiler nodes are included in the overall plant nodal network which is schematically shown in Figure 5. Each plant component is represented by one (in the case of the pipes and converging junctions), two (in the case of the radiators), or more nodes. For every node in the plant network, one (for an energy only component), two (for energy plus 1st phase mass flow (water or dry air)), or three (for energy plus 1st phase (dry air) plus 2nd phase (water vapour)) conservation equations are established at each time-step. These conservation equations are combined into a matrix equation representing the whole network, and are solved simultaneously for each time-step (for more details see Clarke 1985, or Hensen 1991).

```

Plant comp : boiler
a Component total mass (kg) : 1000,0
b Mass weighted average specific heat (J/kgK) : 951,00
c fuel mass flow rate (kg/s) : 0,12600E-02
d volumetric ratio of CO2 in flue gases during opera : 0,13600
e heat exchange coefficient water/flue gases in nomi : 60,000
f sensitivity coefficient for 3 (-) : 0,50000
g sensitivity coefficient for 3 (-) : 0,50000E-02
h heat loss to the environment if OFF (W/K) : 4,2080
i heat loss increase to environment if ON (W/K) : 9,7920
j weighting factor for defining mean water temperatu : 0,50000
k fuel nominal mass flow rate (kg/s) : 0,12600E-02
l water nominal mass flow rate (kg/s) : 0,60000
m nominal ratio of CO2 in flue gases (-) : 0,13600
n coefficient for defining specific heat flue gases : 3294,0
o coefficient for defining specific heat flue gases : 2105,0
p fuel specific heat (J/kgK) : 1880,0
q fuel heating value (J/kg) : 0,42875E+08

< Index select
? Help
- Exit

```

Figure 6 Boiler model parameters for base-case configuration

Figure 6 shows the model parameter setting for the base-case configuration of the boiler, which correspond to a traditionally sized (i.e. over-sized), heavy-weight boiler. The parameter values were derived from (Dachelet et al. 1988) but scaled to a

boiler size of 52 kW (waterside output). The marked parameters have been varied in the simulations as described in the next section.

The aquastat of the boiler was set to 90 C. The boiler is ON/OFF controlled based on comparison of the temperature sensed in a reference zone with the set-point of the central thermostat.

```

Plant comp : pump
a Component total mass (kg) : 5,0000
b Mass weighted average specific heat (J/kgK) : 2250,0
c UA modulus from wall to environment (W/K) : 0,20000
d Rated total absorbed power (W) : 150,00
e Rated volume flow rate (m³/s) : 0,10000E-02
f Overall efficiency (-) : 0,70000

< Index select
? Help
- Exit

```

Figure 7 Pump model parameters

```

Plant comp : rad-1
a Component total mass (kg) : 125,00
b Mass weighted average specific heat (J/kgK) : 600,00
c Radiator exponent (-) : 1,3000
d Nominal heat emission of radiator (W) : 5400,0
e Nominal supply temperature (C) : 90,000
f Nominal exit temperature (C) : 70,000
g Nominal environment temperature (C) : 20,000
h Index of coupled building zone (-) : 4,0000
i Number of walls used for defining Te (-) : 1,0000
j Index of 1st wall for defining Te (-) : 5,0000
k Weighting factor 1st wall when defining Te (-) : 0,20000
l Index of 2nd wall for defining Te (-) : 0,00000E+00
m Weighting factor 2nd wall when defining Te (-) : 0,00000E+00

< Index select
? Help
- Exit

```

Figure 8 Radiator model parameters

Figure 7 and Figure 8 show the model parameter setting for the base-case configuration of the pump and one of the radiators, respectively. The nominal output of each radiator is indicated in Figure 2. The values were derived from prevailing Czech standards.

The pump and radiator parameters have not yet been varied. This will form part of further work in the project.

SIMULATIONS and RESULTS

Simulations have been carried out for four different boiler configurations representing heavy-weight (**H**) or light-weight (**L**) construction of the boiler, and sized according to prevailing Czech heating system design (**D**) standards, or sized according to current practice (**O**) (i.e. over-sized relative to prevailing standards). The corresponding boiler model parameters are:

Boiler code	HO	LO	HD	LD
total mass [kg]	1000	100	1000	100
fuel mass flow rate [kg/s]	.00126	.00126	.00076	.00076
output [kW]	55	55	32	32

From the results there appeared to be almost no difference between the 44 kW and the 55 kW boiler, which is why the 44 kW boiler results are not included in the results analyses.

The simulations were carried out for two days of a climatic reference year which is actually for Kew

near London, but is considered relevant for the Prague region for the selected periods: a typical winter day (8 January) and a typical spring day (3 April).

The heating system was active during 24 hours per day, with a constant room thermostat temperature of 21 C, and assuming zone C-west_1 (see Figure 3) as the reference zone.

The simulations were carried out with a building-side computational time-step of 2 minutes, and a plant-side time-step of 1 minute.

Due to the large thermal inertia of the building, for each simulation run a simulation start-up period of 25 days was used

The results in terms of fuel consumption are:

Gas consumption [m3/day]

	HO	LO	HD	LD
Winter	21.32	21.47	20.41	20.19
Spring	16.48	17.24	14.97	15.24
Average	18.90	19.35	17.69	17.71
%	100%	+2.4%	-6.4%	-6.3%

from which it is obvious that reducing the boiler size will also reduce the fuel consumption. In the over-sized case the heavier boiler has a lower fuel consumption. In the design-sized case there is almost no difference between the heavy-weight and the light-weight boiler.

In terms of boiler usage the results are:

Operational time [hours/day]

	HO	LO	HD	LD
Winter	4.70	4.73	7.50	7.42
Spring	3.63	3.80	5.50	5.60
Average	4.17	4.27	6.50	6.51
%	100%	+2.4%	+56%	+56%

indicating that the smaller boiler is much more intensively used than the larger boiler. It is interesting to note that the smaller boiler is still only in use around 30% of the total time during a cold winter day.

Results in terms of water-side efficiency are:

Boiler efficiency during operation [-]

	HO	LO	HD	LD
Winter	0.91	0.91	0.97	0.97
Spring	0.91	0.91	0.97	0.97
Average	0.91	0.91	0.97	0.97
%	100%	-0.17%	+6.9%	+6.8%

which suggests a very high efficiency for the smaller boiler. We are not confident that this very high efficiency is actually realistic, and suspect that this high prediction results from model scaling errors. Future work should lead to more accurate estimates of boiler model parameters such as: heat exchange coefficient between water and flue gasses, and heat losses to the environment.

Having mentioned this, we do feel that the gas consumption results have a reasonable validity as long as they are interpreted in a relative sense.

Although not distinguishable in the above table, the heavier boiler actually showed marginally higher efficiencies than the lighter boiler, and the efficiencies are also slightly higher in the spring when compared to the colder winter period.

The temperature results, should not be affected by the above indicated model scaling problem.

Some results in terms of air temperatures are shown in the following graphs:

T_{air} in reference zone "C-west 1"

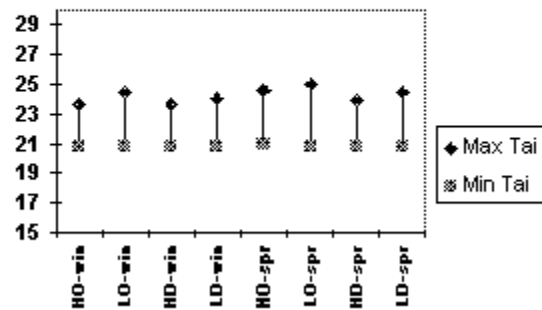

From the results for the reference zone it may be concluded that the thermostat does maintain the temperature at a minimum of 21 C, but is not able to control the upper limit of the air temperature. This can be observed for both the winter and the spring period. There is almost no difference between the light-weight and heavy-weight boiler, and between the over-sized and reduced size boiler.

The relatively high maximum air temperatures result from "temperature overshoot" caused by the high thermal inertia of the system (cast-iron radiators, high water content). It is clear that - for proper control - the system would need some form of "anticipation control" which would turn the boiler off prior to the room air temperature reaching the desired level.

T_{air} in warmest zone "B-east-1"

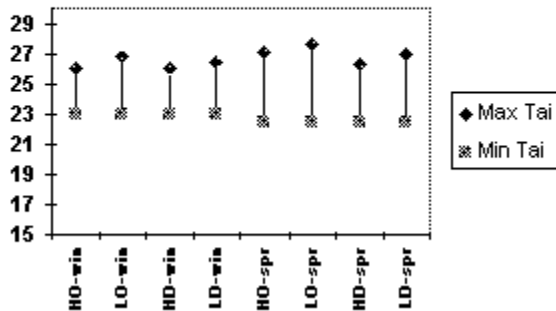

From comparison of the air temperatures in the reference zone with the air temperatures in the warmest zone (i.e. B-east 1) it follows that the temperatures in the latter zone are always about 2 C higher. This shift is due to incorrect sizing of the radiator in that room, and could easily be remedied by installation of a simple valve.

T_{air} in the coldest heated zone "A-west-2"

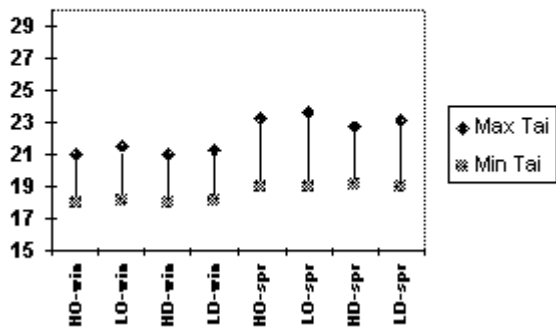

The air temperatures in the coldest zone (A-west 2), show a down-ward shift relative to the reference zone. This is due to a too small radiator in that room, which can only be remedied by changing the radiator or adding a radiator.

CONCLUSIONS

This paper described the general approach and some initial results of an ongoing study which aims to provide design knowledge/information for refurbishment of WCH systems in existing multi-family houses.

From these initial results already a number of interesting conclusions can be drawn in terms of both the application area, and the technology used, i.e. modelling and simulation.

In terms of the considered WCH heating system it

can be concluded that:

1. Over-sizing the boiler will increase the gas consumption on average about 10% with almost no effect on the indoor temperatures.
2. A boiler 30% smaller than the installed radiator capacity but in size conforming to the building heat loss calculations is able to keep the indoor temperature in the comfort range.
3. When the boiler is over-sized, a heavier boiler will have a lower gas consumption; in the current case about 3%. For a boiler sized according to heat losses, the influence of boiler mass is much smaller. However, during the winter the lighter boiler performs better, while during the spring the heavier boiler performs slightly better.
4. In the current case the heating system is not very well balanced, resulting in instantaneous air temperature differences between the coolest and warmest zone of about 5 C, which is considerably higher than the normally accepted 3 C. For the rooms which are too warm this can easily be remedied by installing a simple valve. For the rooms which are too cold there is a need to introduce additional radiator capacity.
5. Due to the high inertia of the system (which is mainly caused by the radiators and the contained water, as opposed to the mass of the boiler) there is a definite need for an anticipating controller.

In terms of modelling and simulation it can be concluded that:

1. It is rather difficult to establish correct parameter values for various explicit plant component models.
2. Currently there is no climatic reference year available for the Czech Republic.
3. Although it is necessary for a study as described in this paper, it should be recognised that high resolution modelling of system involves a lot of resources in terms of setting up the model, verifying both the input and output data, and in terms of analysing the results.

Future work in the current project will include:

1. Incorporation of different WCH control systems, such as central control with anticipation, room-level control with thermostatic valves, etc.
2. Investigation of the effect of intermittent heating as opposed to the continuous operation which has been assumed in the current paper.
3. Verification of the plant component models in general, and the boiler model in particular. Ideally this would involve experimental work.

Although there are various problems which need to be resolved, and although the work involved is more than expected, we do feel that integrated modelling and simulation of the building and plant is the way

ahead for addressing design and control problems related to building integrated systems, such as WCH systems.

REFERENCES

Clarke, J.A. 1985. "Energy simulation in building design", Adam Hilger Ltd, Bristol

Dachelet, M., J.P. Eppe, J. Hannay, L. Laret, J. Lebrun, G. Liebecq, and B. Lorea 1988. "HVAC component specification: fuel oil boiler, "Energy conservation in buildings & community systems programme. Annex X : system simulation (S1), International Energy Agency. Operating agent: University of Liege

ESRU 1996. "ESP-r A Building Energy Simulation Environment; User Guide Version 9 Series, "ESRU Manual U96/1, University of Strathclyde, Energy Systems Research Unit, Glasgow.

Hensen, J.L.M. 1991. "On the thermal interaction of building structure and heating and ventilating system, "Doctoral dissertation Eindhoven University of Technology (FAGO). (ISBN 90-386-0081-X)

Hensen, J.L.M. 1995. "On system simulation for building performance evaluation," in Proc. 4th

IBPSA World Congress "Building Simulation '95", Madison, Aug 1995, pp. 259-267, Int. Building Performance Simulation Association, Madison, WI

Kabele, K. 1996a. "Heating systems with combined boiler", Topenarstvi Instalace.No.5,pp. 45-48 (in Czech)

Kabele, K. 1996b. "Heating systems modelling and performance simulation as a tool for computer aided engineering design" in Proc. CIB W67 Symposium Energy and mass flow in the life cycle of the buildings, Vienna

Laret, L. 1988. "Boiler physical model for use in large scale building simulation," in Proc. USER 1 working conference at Ostend, pp. 23-28, Society for Computer Simulation International, Ghent (B).

Laret, L. 1989. "Accurate boiler models for large scale simulation," in Proc. Building Simulation '89, pp. 375-380, International Building Performance Simulation Association IBPSA, Vancouver.

SEL 1994. TRNSYS, a transient system simulation program, University of Wisconsin-Madison, Solar Energy Laboratory, Madison, WI. Manual for version 14.1 and later